

SUPER VIEW® Wide Angle Viewing System Installation Diagram

Takagi OM-9

- 1: US
- 2: EU
- 3: UK
- 4: AU

- 5: Manual [not shown]
- 6: Automatic

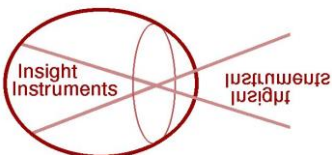
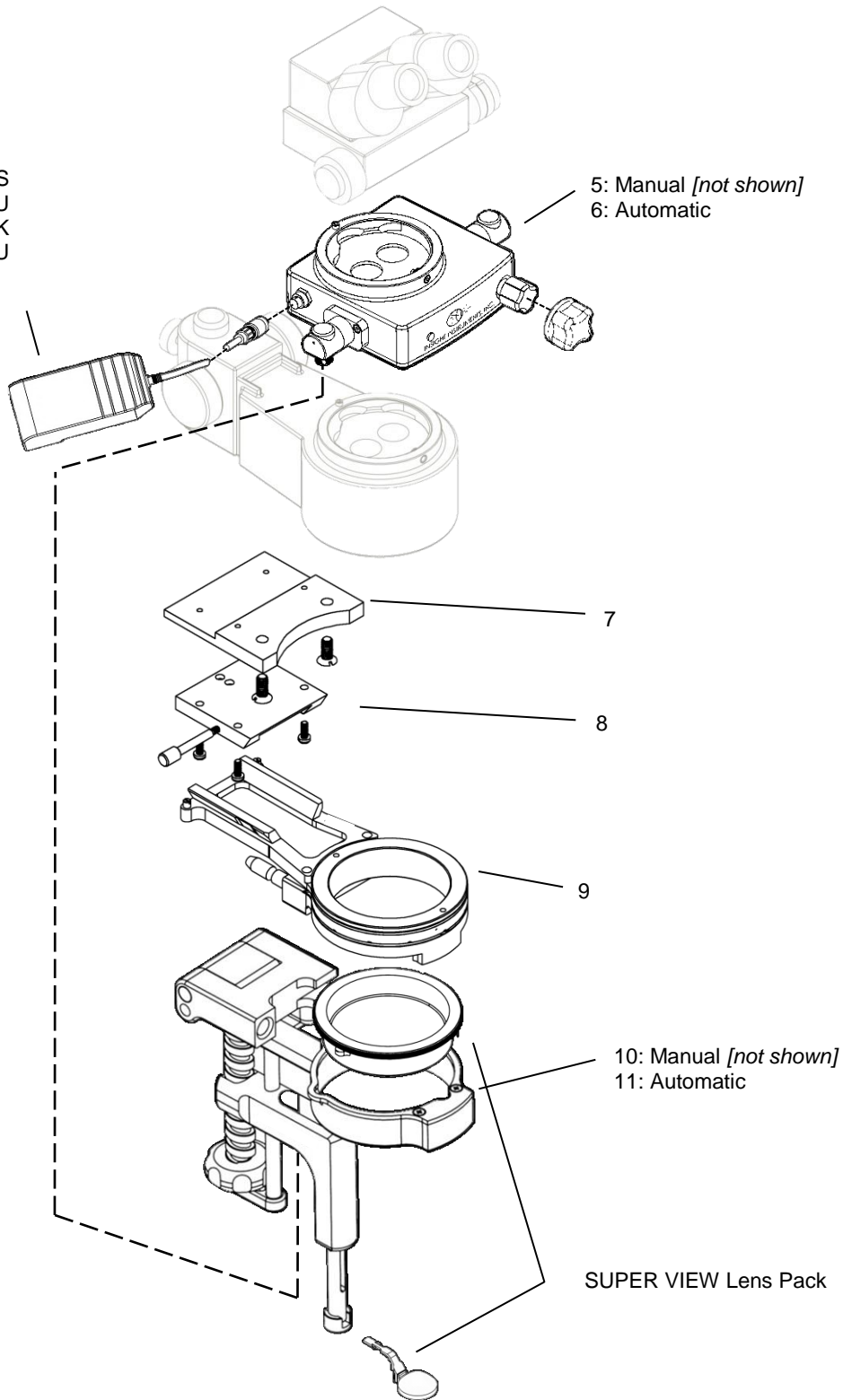

Insight Instruments, Inc.
 2580 S.E. Willoughby Blvd. Stuart, FL 34994
 Tel: 772-219-9393; US: 800-255-8354
 Fax: 772-219-9342
www.InsightInstruments.com



ID-43025 R0
 ECN-1414